

Lift and Dispense a Drum with Your Forklift

Forklift-Karriers - 800 Lb. (363 kg) Capacity

- Quickly mount on your forklift
 - No tools or truck modifications
 - No electric or hydraulic connections
- Provides controlled drum pouring
- Allows 360° drum tilt control in both directions
- Eliminates backbreaking labor and dangerous, makeshift methods
- Model 285AM has spark resistant parts

Morse Forklift-Karriers have a 20' (6 m) long pull chain loop with 10' (3 m) drop so you control drum tilting, 360° in either direction. Dispense a drum right from your forklift. Can also be ordered with Hand Crank or Hand Wheel option for use only within reach.

We recommend the MORStop Tilt-Brake option to automatically hold the drum tilt angle until you move it. This prevents a partially full, unbalanced drum from turning out of control, even when the contents shift from one end to the other.

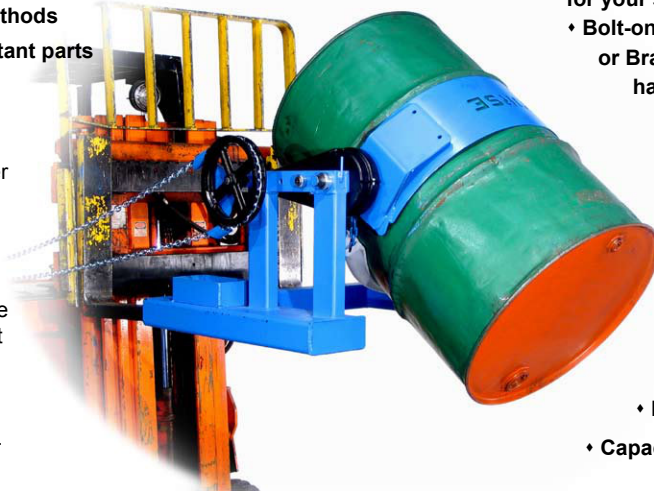

>> Click to Watch Video <<

MORCINCH™ Drum Handling System

- Automatically adjusts for 22" to 23.5" (56 to 59.7 cm) diameter drum
- Accepts Diameter Adaptors for your smaller drum
 - Bolt-on Top Rim Clamp or Bracket Assembly to handle a plastic or fiber drum



- Includes a flexible cinch chain cover to help protect the sidewall of your drum
- Incorporates alloy cinch chain and durable stress relief weld joints

Models 285A & 285AM

- Chain wheel controlled tilt with 30:1 gear ratio and safety cover
- Handle drum with drum faucet in place
- Capacity: 800 Lb. (363 kg) full-drum
500 Lb. (227 kg) half-full drum

Half-full rating is an indication of capacity for tilting an unbalanced, bottom-heavy drum. A partially full drum with unbalanced and shifting load is harder to tilt than a full drum.

Ships Domestic: Class 70, L42"xW34"xH23" (107x87x59 cm)
Ship Weight: 285A 161 Lb. (73 kg), 285AM 167 Lb. (76 kg)

Model	Description	MORStop Tilt-Brake Option	Hand Crank Option	Hand Wheel Option	Adaptors for Smaller Drum
285A	Forklift-Karrier	3900i-P	X02-285	X03-285	55/30 Series
285AM	Forklift-Karrier with Spark Resistant Parts	3900i-P	X02-285M	X03-285M	55/30M Series

MORCINCH™ Drum Handling System

Rimless Plastic Drum Bracket Assembly
Handle rimless poly drum or more securely handle a fiber drum



The **Bracket Assembly** provides a brace at top and bottom of your drum to prevent it from slipping lengthways through the drum holder. The Bracket Assembly is required to handle a rimless plastic drum, and recommended to more securely handle a fiber drum. It adjusts for 31" to 39" (79 to 99 cm) tall drum.

Kit # 4556-P Bracket Assembly.
Kit # 4556M-P Spark Resistant

Rimmed Plastic Drum Top Rim Clamp
for 55-gallon (210 liter) rimmed plastic or fiber drum

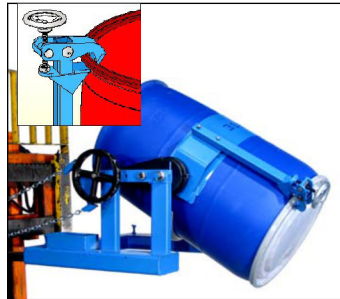

The **Top Rim Clamp** grips the upper rim of your drum to prevent it from slipping through the drum holder. Use to handle a 55-gallon (210 liter) rimmed plastic or fiber drum. To handle a 55-gallon plastic drum with top rim, you must install either the Bracket Assembly or the Top Rim Clamp.

Kit # 4560-P Rim Clamp Assembly.
Kit # 4560M-P Spark Resistant Rim Clamp Assembly.

Smaller Drum Diameter Adaptors
for Smaller Diameter Drum

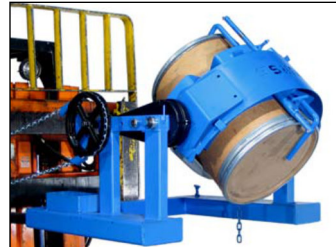

Diameter Adaptors insert into the drum holder to handle a smaller drum. Select the correct size Diameter Adaptor for each drum. Spark resistant and stainless steel Diameter Adaptors also available.

Web Strap with Ratchet



Option # 5115i-P Web Strap and Ratchet installed (not for spark resistant models)

Installed Options

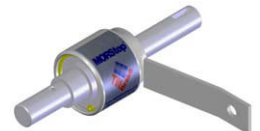

We recommend **Option # 3900i-P MORStop Tilt-Brake** factory installed on your Forklift-Karrier is recommended to automatically hold the drum tilt angle.

Kit # 3900-P MORStop Tilt-Brake Kit for field installation.



Option X02-285 or X02-285M
9" (22.9 cm)
Hand Crank

Option X03-285 or X03-285M
16" (40.6 cm)
Hand Wheel

Diameter Adaptors

Diameter Adaptors allow your Forklift-Karrier to handle a smaller drum. Simply place the correct size Diameter Adaptor into the drum holder. When you complete dispensing from your smaller drum, simply lift the Diameter Adaptor out of the drum holder to return to handling a 55-gallon (210 liter) drum.



Model 55/30-19

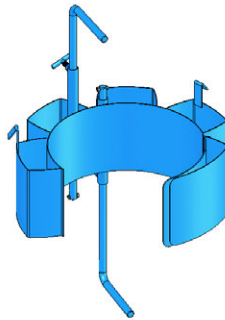

Model 55/30-17.5

Diameter Adaptors for 17.5" (44.5 cm) diameter and smaller drums have brackets at top and bottom of the drum. They adjust to securely hold a drum up to 38" (96.5 cm) tall.

Spark resistant and stainless steel Diameter Adaptors are available for the same diameter ranges.

DIAMETER ADAPTORS				
DIAMETER ADAPTORS	SPARK RESISTANT DIAMETER ADAPTORS	STAINLESS STEEL DIAMETER ADAPTORS	FITS DIAMETER	DOMESTIC SHIP WEIGHT
55/30-20.5	55/30M-20.5	55/30SS-20.5	20" to 20.5" (50.8 to 52.1 cm)	20 Lb. (9 kg)
55/30-19	55/30M-19	55/30SS-19	18.5" to 19" (47 to 48.3 cm)	24 Lb. (11 kg)
55/30-17.5	55/30M-17.5	55/30SS-17.5	17" to 17.5" (43.2 to 44.5 cm)	35 Lb. (16 kg)
55/30-16	55/30M-16	55/30SS-16	15.5" to 16" 39.4 to 40.6 cm)	35 Lb. (16 kg)
55/30-14.5	55/30M-14.5	55/30SS-14.5	14" to 14.5" (35.6 to 36.8 cm)	36 Lb. (16 kg)

285 Series Dimensions

IMPORTANT: Requires 25" Between Forks

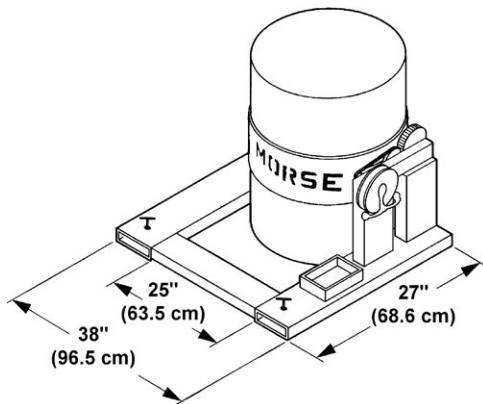

Fork pocket openings are 6.5" wide x 2.5" high (16.5 x 6.35 cm).

Fork pockets are 26.5" deep (67.3 cm).

Inside width between forks MUST be at least 25" (63.5 cm).

NOTE: Standard loop of pull chain extends approximately 10' (3 m) beyond the chain wheel. Custom lengths are available.

Steps For Use of Forklift-Karriers

1. Drive your truck forks into the Forklift-Karrier's fork pockets.
2. Dismount and screw down the safety locks to grip the forks.
3. Drive to a drum at ground level, so that the drum holder meets the center of your drum.
4. Secure your drum in the drum holder between drum ribs... no tools are needed. To secure drum, drape the cinch chain with flexible chain cover across the front of the drum, insert one link into the slot on the ratchet handle, and turn the ratchet handle clockwise to tighten the cinch chain around the drum.
5. If your Forklift-Karrier is so equipped, tighten the Top Rim Clamp or adjust the Bracket Assembly height.
6. Raise your forklift carriage and the secured drum, then travel to the dumping location.
7. To control turning of the drum without leaving your seat, pull the chain loop for complete control of drum tilting.
8. To remove drum from your Forklift-Karrier, turn the ratchet handle clockwise to relieve pressure on the ratchet teeth, lift pawl handle to release teeth engagement, then rotate the ratchet handle counter clockwise to loosen the chain and allow its removal from the slot on the ratchet handle.

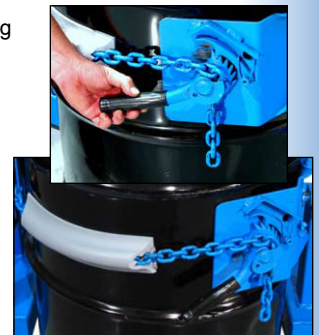
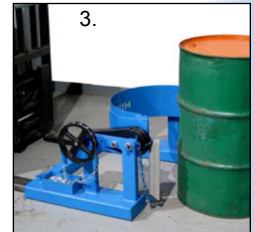
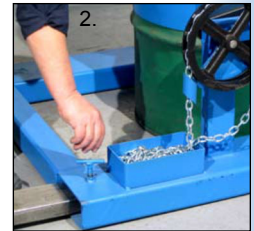

MADE IN USA

Custom Drum Handler



Custom model 185S-HD-FP handles drum completely below the forks or below-hook

Use with:

- Walkie Stacker Requires 17-7/17" (44.3 cm) between forks
- Forklift
- Crane or Hoist below-hook